

EN Motion detector

theMova S360-101 DE WH

1030565

theMova S360-101 FLAT DE WH

1030545

theMova S360-101 AP WH

1030555

theMova S360-101 AP GR

1030556



1. Product characteristics

- Passive infra-red motion detector for ceiling installation
- Circular detection area 360°, up to Ø 9 m (64 m²)
- Automatic motion and brightness-dependent control for lighting and HVAC
- Mixed light measurement suitable for fluorescent lamps (FL/PL/ESL), halogen/incandescent lamps and LEDs
- Channel A light: relay, 230 V
- Operation as fully automatic device
- Brightness switching value configurable, teach-in function
- Pulse function for staircase light time switch
- Channel H, presence: relay, floating e.g. for HVAC control
- Time delay configurable
- Detection sensitivity configurable
- Ready for immediate use due to factory presetting
- Test mode for checking function and detection area
- Installation in false ceilings with springs, type DE
- Surface mount on ceiling, type AP
- User remote control „theSenda S“ (option)
- Management remote control „SendoPro“ (optional)
- Service remote control „theSendaP“ (option)
- App remote control „theSenda B“ (option) and corresponding app „theSenda Plug“ (iOS/Android)

2. Safety



WARNING

Danger of death through electric shock or fire!

- Installation should only be carried out by a professional electrician!

- Work on electrical systems may only be carried out by electricians or by instructed persons under the leadership and supervision of an electrician in accordance with the technical regulations applying to electricity!
- Comply with the country-specific safety regulations for work on electrical systems! Ensure absence of voltage in the cable before installation!
- The device is maintenance-free. If the device is opened or penetrated with any objects the guarantee lapses.

3. Intended use

The motion detector is intended for interior installation. The motion detector is exclusively intended for the use as contractually agreed between the manufacturer and the user. Any other use is considered to be unacceptable. The manufacturer does not accept liability for any resulting damages.

4. Function

The motion detector is primarily used in passage ways such as corridors, stairs, toilets, basements and garages as well as in homes for easy and energy-efficient control of lighting plus HVAC. The switch contact „light“ switches lighting on with presence and insufficient brightness, and off with absence. The „Presence“ switch contact controls heating, ventilation and air conditioning systems. The contact closes when people are present.

Functional description

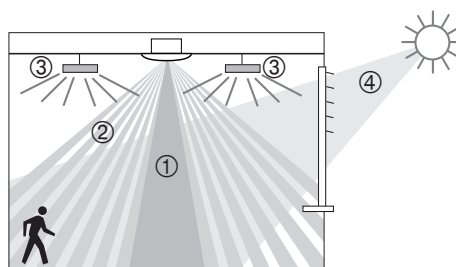

- ① Mixed light measurement
- ② Motion detection
- ③ Artificial light
- ④ Incident daylight

Channel A light

Switching response is controlled by presence and brightness. The switch contact for channel A light closes during darkness and when someone is present. It opens with a delay once the room is vacated after the set time delay.

Time delay

The time delay enables delayed switching off of lighting after the room is vacated. The time delay is adjustable in a range of 10 s to 60 min.

Fully automatic

Lighting control of the motion detector operates fully automatically for increased comfort. In „fully automatic“ the lights switch on and off automatically.

Pulse function

Time delay can be set to pulse for controlling existing staircase light timer switch. To do so, the light output produces every 10 seconds a pulse of 0.5 seconds duration if people are present or it is dark.

Channel H presence

Channel H presence is used for HVAC control. The switching response of the floating contact is influenced only by presence and not by brightness. If the contact is closed, the time delay will be restarted at every motion.

Time delay

The time delay enables delayed switching off of HVAC devices and systems after the room is vacated. The time delay is adjustable in a range of 10 s to 120 min.

5. Detection area

The circular detection area of the Mova S motion detector covers an average detection area. Note that moving persons can be detected in differently-sized areas. The recommended installation height is 2.0 m – 4.0 m. As installation height increases, the sensitivity of the presence detector decreases. The extent and distance between the active and passive zones of the motion detector also increases. The detection range is reduced as temperatures increase.

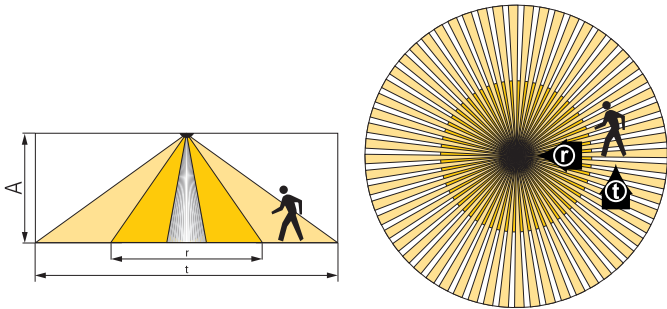

Installation height (A)	Moving persons Frontal (r)		Moving persons Across (t)	
	Area (m ²)	Radius (m)	Area (m ²)	Radius (m)
2.0 m	5 m ²	∅ 2.5 m	38 m ²	∅ 7 m
2.5 m	7 m ²	∅ 3 m	38 m ²	∅ 7 m
3.0 m	13 m ²	∅ 4 m	50 m ²	∅ 8 m
3.5 m	13 m ²	∅ 4 m	50 m ²	∅ 8 m
4.0 m	13 m ²	∅ 4 m	64 m ²	∅ 9 m

All figures are guidance values (detection areas according to sensNORM IEC 63180, see data sheet).

Brightness measurement

The motion detector measures artificial light and daylight that is reflected below the detector. The light measurement area maps a rectangle of about 1.8 x 3 m at table height. The installation site is a reference point for the lighting level. The light measurement is switched off when the light relay is switched on. If the brightness measurement is deactivated, the channel A light only switches depending on the presence (brightness switching value set to „measurement off“ via the remote control).

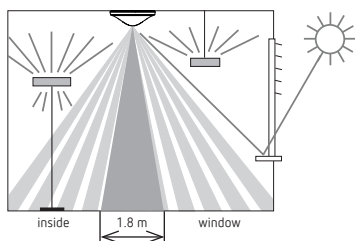

Suitable lamps

The motion detector is designed for the operation of fluorescent lamps, compact fluorescent lamps, halogen/incandescent lamps and LEDs. The maximum number of switchable lights is restricted due to the high inrush current levels of the EBs and LED drivers. The use of an external contactor helps with large loads. All switched loads must be properly suppressed.

6. Installation

Ceiling installation

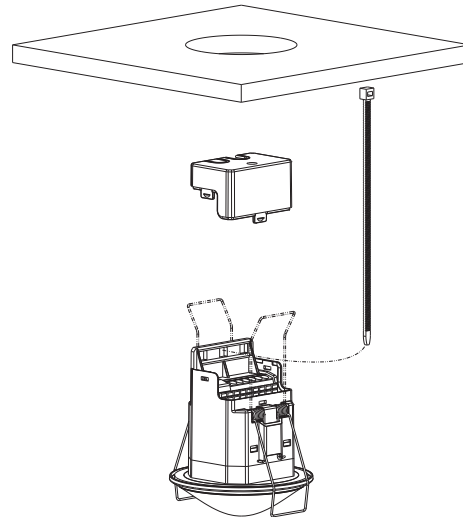

Installation in false ceilings for ceiling thicknesses of 0.5 mm to 3 cm. The diameter of ceiling cutouts must be between 62 mm and 70 mm. The cable strain relief is with using a cable tie (width: 3.5 – 4.8 mm).

The detector requires a clear line of sight to people. The installation height must be no less 1.7 m and no higher than 4 m.

Surface mount on ceiling

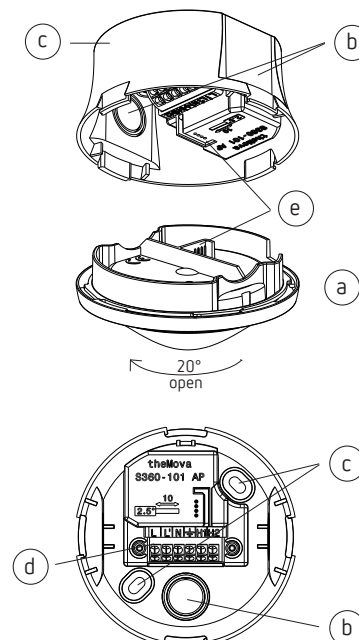

- Rotate sensor assembly approx. 20° anticlockwise until it clicks.
- Detach sensor assembly.
- Open knock-outs as needed to feed wires through.
- Mount power assembly on ceiling via the fixing holes.
- Connect wiring according to markings on push-in terminals; conductor cross-section 0.25 – 2.5 mm².
- Attach sensor assembly (a), taking care to insert plug-in connector (e)

7. Switching

The motion detectors can be operated as a master in individual switching. With parallel connection of the light outputs (L'), it must be ensured that all detectors connected in parallel are connected to the same phase.

Individual switching

In individual switching, the motion detector as master detects presence and brightness and controls lighting.

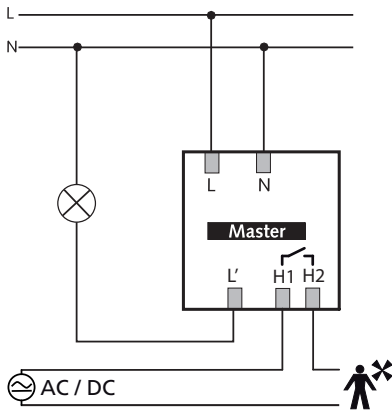

8. Settings

Motion detector theMova S does not have a potentiometer. The motion detectors are supplied with basic settings ready for operation. The specifications are guidance values. Management remote control „SendoPro 868-A“, service remote control „theSenda P“ and app remote control „theSenda B“ (with „theSenda Plug“ app) are available for start-up. They allow the remote adjustment of the setting values.

Parameters via remote control

The following parameters can be queried or changed via the remote control for support during installation as well as servicing:

Parameter	Description	Can be queried by SendoPro 868-A/ theSenda B (app)	Can be changed by SendoPro 868-A/ theSenda B (app)	Can be changed theSenda P
Brightness switching value Channel A light	Value range in lux	x	x	x
	Measurement off	x	x	

Parameter	Description	Can be queried by SendoPro 868-A/ theSenda B (app)	Can be changed by SendoPro 868-A/ theSenda B (app)	Can be changed theSenda P
Brightness actual value channel A light	Value range in lux	X		
Lighting time delay	Value ranges in seconds and minutes		x	x
	Pulse		x	x
Presence time delay	Value ranges in seconds and minutes		x	x
Detection sensitivity (PIR)	Value range in levels		x	x
Group address channel A light	All / I / II / III		x	
LED display motion	Off / On		x	

The parameters are sent to the presence detector via infrared by using the „SendoPro 868-A“ management remote control, the „theSenda P“ service remote control, or „theSenda B“ app remote control (with „theSenda Plug“ app). Changed parameters are immediately applied and used by the detector.

With the „SendoPro 868-A“ management remote control, as well as with „theSenda B“ app remote control (with „theSenda Plug“ app), parameters can be queried by sending values level-by-level to the detector. If the sent values are below the set parameter, the LED illuminates briefly. If the sent values are equal or above the set parameter, the LED flickers for 2 seconds.

Control commands via remote control

Control command	Description	Can be triggered by SendoPro 868-A/ theSenda B (app)	Can be triggered theSenda P
Teach-in channel A light	Activate	x	x
Switch lights on/off	Lighting group can be switched on and off.	x	x
Presence test	On / Off	x	x
Restart	Restart detector	x	x
Factory regulations	Set all parameters and settings to factory setting.	x	

Brightness switching value Channel A light

The brightness switching value defines the minimum desired brightness. The current prevailing brightness is measured below the motion detector. If the prevailing brightness is below the switching value, the light switches on as soon as a presence is detected.

Value range

Adjustable values "SendoPro 868-A"/"theSenda B" (app)	30–3000 lux
Adjustable values "theSenda P"	30, 300, 500, 800 lux

Deactivation of brightness measurement (brightness measurement has no effect) The light channels only switch according to presence and absence.	
"SendoPro 868-A" / "theSenda B" (app)	Measurement off
"theSenda P"	Button ☀

Teach-in channel A light

During teach-in, the currently measured brightness value is accepted as brightness setpoint value A. Values outside the permitted range will automatically be set to the appropriate limit value.

"SendoPro 868-A" / "theSenda B" (app)	Teach-in
"theSenda P"	Button 👁

Time delay channel A light

Value range

Adjustable values "SendoPro 868-A" / "theSenda B" (app)	10 s – 60 min
Adjustable values "theSenda P"	10 s, 30 s, 60 s, 2 min, 10 min, 20 min, 60 min

Control for staircase light timer switch (0.5 s "on" / 10 s "off")	
"SendoPro 868-A" / "theSenda B" (app)	Pulse
"theSenda P"	Button ⏸

Time delay channel H Presence

The presence channel switches on the basis of the presence (without brightness as a factor). The relay contact opens once the room is vacated after the set time delay expires.



Value range

Adjustable values "SendoPro 868-A" / "theSenda B" (app)	10 s – 120 min
Adjustable values "theSenda P"	10 s, 30 s, 60 s, 2 min, 10 min, 20 min, 120 min

Detection sensitivity

The detector has 5 sensitivity increments. The basic setting is the middle increment (3).

With the „SendoPro 868-A“ management remote control, as well as with „theSenda B“ app remote control (with „theSenda Plug“ app), the increments 1 to 5 can be selected and sent to the detector.

With the „theSenda P“ installation remote control, the sensitivity can be decreased  or increased  by one increment each time the button is pushed.

Level	Sensitivity
1	very insensitive
2	insensitive
3	Standard
4	sensitive
5	very sensitive

Group address channel A light

This parameter is applied when using the „theSenda S“ user remote control.

A group address can be assigned to channel A light.

The group addresses can be programmed with the following remote controls:

Group address value range

Adjustable values "SendoPro 868-A"	I, II, III, All
Adjustable values "theSenda B"	I, II, III
Adjustable values "theSenda Plug"	I–VIII, All
Adjustable values "theSenda S"	I, II

LED display motion

The motion detection can be displayed via the LED.

Value range (only with management remote control SendoPro 868-A/theSenda B (App))

No display of motion detection.	Off
The LED switches on when motion is detected, otherwise switches off.	On

Factory settings

The theMova P360-101 motion detector is supplied with the following parameter values:

Parameter	Value
Brightness switching value Channel A light	300 lux
Lighting time delay	10 min
Presence time delay	10 min
Detection sensitivity (PIR)	Stage 3
Group address channel A light	T
LED display motion	Off

9. Start-up

Switching behaviour

Every time the power supply is switched on, the motion detector first runs through a start-up phase of 30 s, and then switches to normal operation. A LED displays the current status:

1. Start-up phase (30 seconds)

- The red LED flashes every second, both switch contacts are closed (light and presence on).
- The detector does not react to remote control commands.
- When no one is present both contacts open after 30 seconds.

2. Operation

The detector is ready for operation (LED off).

Presence test mode

The test mode detection area is used to test presence detection and wiring. Presence test mode can be activated with „SendoPro 868-A“ management remote control, with „theSenda B“ app remote control (with „theSenda Plug“ app) and with „theSenda P“ installation remote control.

Setting test mode detection area with remote control

- The detector goes directly into test mode when the test mode is set via the remote control:
 - Every movement is indicated by the LED.
 - When movement occurs the light and presence switch contacts close.
 - When no one is present the light switch contact opens after 10 seconds.
 - Brightness measurement deactivates, detector does not react to brightness.
 - Teach-in cannot be activated in test mode.
- Test mode ends automatically after 10 mins. The detector performs a new start (see switch-on behaviour).

10. Technical data

Operating voltage	230 V AC +- 10 %
Frequency	50 Hz
Upstream protection device:	13 A
Power consumption	approx. 0.5 W
Type of installation	Ceiling installation
Recommended installation height	2.0 – 4.0 m
Minimum height	> 1.7 m
Detection area horizontal	360°
Maximum range	Ø 4 m (Mh. 3 m) / 13 m ² radially moving Ø 8 m (Mh. 3 m) / 50 m ² tangentially moving
Setting range brightness switching value	30 – 3000 Lux
Lighting time delay A light	10 s – 60 min / Pulse
Presence time delay	10 s – 120 min
Channel A light	Relay 230 V / 10 A, µ-contact
Max. switching capacity cos φ 1 resistive	2300 W
Max. switching capacity cos φ 0.5	1150 VA
Max. switching capacity LED	see manufacturer concerning cos φ
Guide values	< 2 W : 25 W / > 2 W : 250 W
Guidance value max. inrush current level	400 A / 200 µs
Maximum number EBs T5/T8	10 x 54/58 W, 16 x 35/36 W 5 x 2 x 54/58 W 8x 2x 35/36 W
Channel H, presence	Floating relay
Maximum voltage	220 V DC / 250 V AC
Maximum switching capacity	50 W / 50 VA (max. 2 A)
Recommended minimum load	0.5 mV / 10 mA
Connection type	Screwless terminals
Max. cable cross-section	max. 2.5 mm ²
Protection rating:	IP 20 (IP 54 installed)
Ambient temperature	-15 °C to +50 °C
CE Declaration of Conformity	This device conforms to the safety regulations of the EMC directive 2014/30/EC and of directive 2014/35/EC.

Product overview

Type of installation	Channel	Operating voltage	Colour	Type	Item No.
Ceiling installation	Light HVAC	230 V AC	White	theMova S360 -101 DE WH	1030565
Ceiling installation	Light HVAC	230 V AC	White	theMova S360-101 FLAT DE WH	1030545
Ceiling installation	Light HVAC	230 V AC	White	theMova S360 -101 AP WH	1030555
Ceiling installation	Light HVAC	230 V AC	Grey	theMova S360 -101 AP GR	1030556
Ceiling installation	Light HVAC	230 V AC	Special colour in accordance with customer information	theMova S360 -101 AP SF	1030558

Troubleshooting

Fault	Cause
Light does not switch on if presence is detected and in darkness	Lux value is set too low; light was switched off via theSenda S; person not within detection area; obstruction(s) interrupting detection; time delay set too short
Light does not switch off and/or light switches on spontaneously when no one is present	Wait for time delay; Thermal sources of interference in the detection area: fan heaters, incandescent lamps/halogen spotlights, moving objects (e.g. curtains hanging in an open windows); Load (EBs, relays) not cleared
Error flashing (4 x per second)	Error in self-test; Device not properly functional!

LED display

LED	Description
Blinking in 1 second cycle	The motion detector is in the start-up phase.
Flickering for 2 s	The command sent from the remote control via infrared was accepted by the motion detector.
Lights up briefly	The command sent from the remote control via infrared was rejected by the motion detector. The command is not valid. Check the selected detector type or parameters on the SendoPro or in the app.
Fast blinking	Error blinking; The motion detector has found an error.
Lights or flickers irregularly	The motion detector is in detection area test mode or "LED display movement" is activated. The LED displays detection of movement.

Dimensional drawings

theMova S360-101 DE

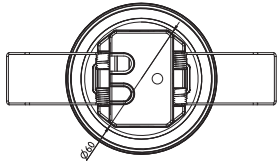
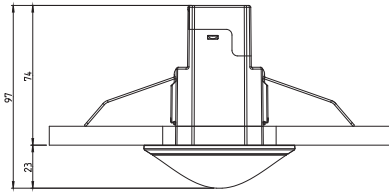

theMova S360-101 FLAT DE WH

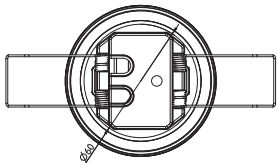
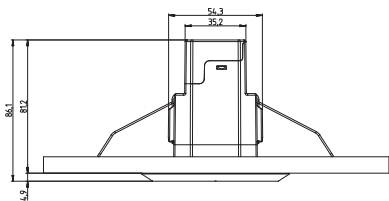

theMova S360-101 AP

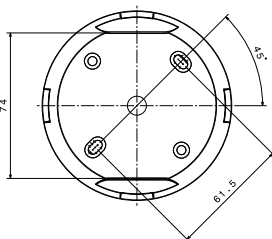
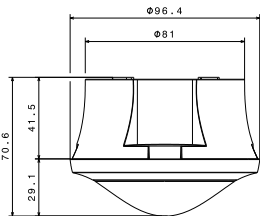

11. Accessories

theSenda B
Item No.: 9070985
[Details > www.theben.de](http://www.theben.de)

theSenda S
Item No.: 9070911
[Details > www.theben.de](http://www.theben.de)

theSenda P
Item no.: 9070910
[Details > www.theben.de](http://www.theben.de)

12. Contact

Theben AG
Hohenbergstraße 32
72401 Haigerloch
GERMANY
Phone: +49 7474/692-0
Fax: +49 7474/692-150
Hotline
Phone: +49 7474/692-369
hotline@theben.de
www.theben.de